

External Contamination Environment at ISS

***Including Selected Results from Payloads
Contamination Mapping Delivery 3 Package***

***Presentation to Contamination, Coatings,
Materials, and Planetary Protection Workshop***

**NASA GSFC
July 18-20, 2017**

***Randy Olsen
Alvin Huang
Courtney Steagall
Nathaniel Kohl***

Boeing Space Environments Team



***Steve Koontz
Erica Worthy***
NASA Johnson Space Center





Introduction



- ***The International Space Station (ISS) is the largest and most complex on-orbit platform for space science utilization in low Earth orbit.***
- ***Multiple sites for external payloads, with exposure to the associated natural and induced environments, are available to support a variety of space science utilization objectives.***
- ***Contamination is one of the induced environments that can impact performance, mission success and science utilization on the vehicle.***
- ***The ISS has been designed, built and integrated with strict contamination requirements to provide low levels of induced contamination on external payload assets.***

Space Environments External Contamination Responsibilities



- External contamination design/verification analysis of U.S./International Partner/Russian hardware, FSE, Visiting Vehicles, ISS Payloads and Operations – **complete system integration responsibility**
- Payloads & ISS Science Utilization
 - Responsibility for Space Environments issues for ISS attached payloads (science utilization of the vehicle)
 - Requirements development, attached payload feasibility studies, **Express Logistic Carrier (ELC) contamination forecast mapping** supporting payload topology studies, attached payload integration, verification and anomaly resolution activities
 - Coordination with ISS International Partners (IPs; e.g., European Union, Japan, Russia and Canada) and integration of IP payloads



ISS022E067004

NOTE: JAXA and ESA are responsible for intra-site external contamination modeling analysis for the Japanese Experiment Module – Exposed Facility (JEM-EF) and Columbus Exposed Payload Facility (EPF), respectively



External Payloads on ISS



- ***An external payload is both a source and a receiver of contamination.***
- ***ISS Space Environments Team considers both roles during integration of the payload.***
- ***Thus, Space Environments must evaluate all external payloads as contamination sources, regardless of sensitivity to contamination.***

Requirements Applicable to All Payloads*



➤ ***ISS-Level Requirement***

- ❑ ***SSP 41000, 3.3.10.3 External contamination releases; Release of contaminants to the external on-orbit Space Station environment during quiescent (6.1) and non-quiescent (6.1) periods shall be in accordance with SSP 30426, section 3, except during response to emergency conditions.***

➤ ***Element Level Requirement***

- ❑ ***Pressurized and Attached Payloads contaminant releases shall be in accordance with SSP 30426, Space Station External Contamination Control Requirements, Sections 3.4, 3.5 and 3.6.***

JAXA: SSP 41165, 3.3.15.2 External contamination releases

ESA: SSP 41160, 3.3.10.3 External contamination releases

(NASA Element-level analysis is included within the ISS-level analysis)

**Excerpted from SSP 57011 Revision E*

Attached Payload and ELC Allocations



- Payload requirements per SSP 57003, “External Payload Interface Requirements Document” Rev L
 - Section 3.5.3.2.A limits a payload’s contribution to surface contamination of **another payload** in the form of molecular deposition via materials outgassing according to its mounting location:
 - Single Payload on an ELC: 5.0×10^{-15} gm/ (cm²·sec) [~ 15 Å/year]
 - Truss-mounted payload: 1.0×10^{-14} gm/ (cm²·sec) [~ 30 Å/year]
 - Section 3.5.3.2.B limits an individual payload’s contribution to surface contamination of **ISS surfaces** in the form of molecular deposition via materials outgassing and venting according to its mounting location:
 - Single Payload on an ELC: 5.0×10^{-16} gm/ (cm²·sec) [~ 1.5 Å/year]
 - Truss-mounted payload: 1.0×10^{-15} gm/ (cm²·sec) [~ 3 Å/year]

External Contamination ‘Design To’ Environment



- ***The Payload will be exposed to the ISS on-orbit external contamination environment of:***
 - ❑ ***130 Angstroms/year of total contaminant deposition from all ISS contamination sources combined (quiescent and non-quiescent),***
 - ❑ ***molecular column densities of up to 1.0×10^{14} molecules/cm² for unobstructed lines-of-sight during quiescent periods, and***
 - ❑ ***particulate releases limited to one 100 micron particle per orbit per 1.0×10^{-5} steradian field-of-view during quiescent periods.***
- ***The very low pressure and zero humidity on-orbit can lead to outgassing of chemical constituents for materials and components that are not vacuum stable. This outgassed material can deposit on surrounding hardware and change the optical properties of the coated components, leading to performance degradation of the material or component.***

System Level External Contamination Verification



- Space Environments models, calculates and tracks external contamination due to molecular deposition on the ISS.
- Total system level limit of **130 Å/year** from all sources
 - ISS structure, visiting vehicles, payloads, etc.
- Sample Results from a previous System Level Analysis:

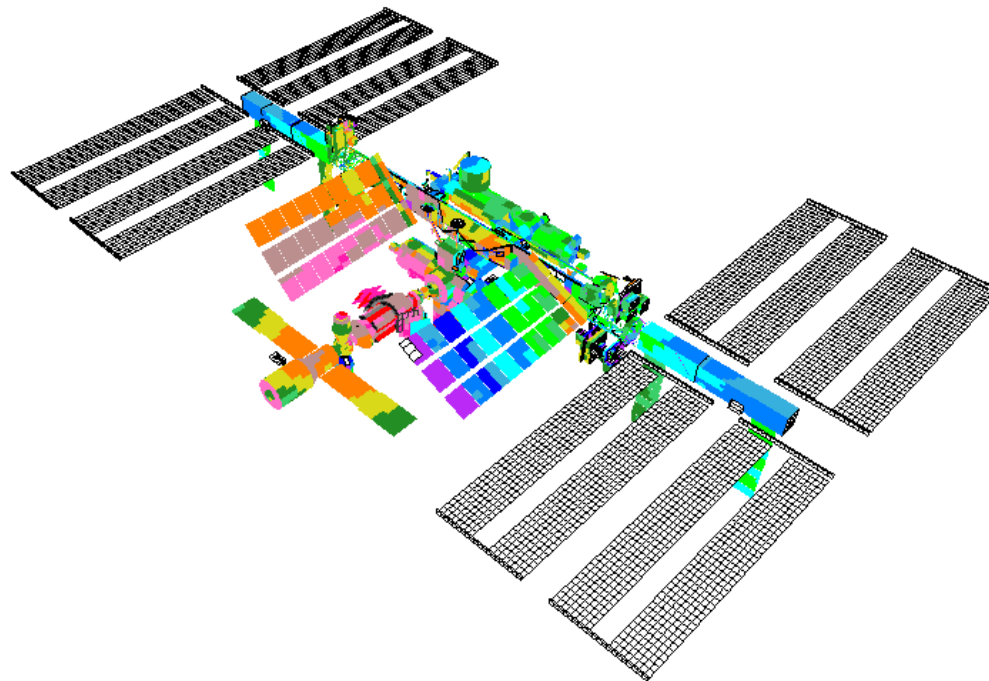
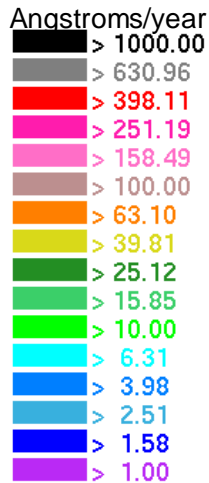



Verification Data Deliverables



- ***Payload developers deliver a characterization of contamination sources on their payloads.***
 - ❑ ***Vacuum exposed materials (all non-metallic materials outside of a pressurized or hermetically sealed environment)***
 - ❑ ***Vacuum venting (liquids and gases)***
 - ❑ ***Leakage***
 - ❑ ***Thrusters***
 - ❑ ***Sources of particulate releases***
- ***Identification of contamination sensitive surfaces on the payload also is required.***
 - ❑ ***This data is used to track induced contamination on the payload from the vehicle (ISS), visiting vehicles and other payloads.***



Verification Data Deliveries



- ***A preliminary and final data delivery are required to support external contamination verification and requirement closure.***
- ***Preliminary Data Delivery (Launch-24 months)***
 - ❑ ***Allows for early resolution of contamination concerns.***
 - ❑ ***Space Environments may request ASTM E-1559 testing for any unusual materials / analysis drivers.***
 - *ASTM E-595 data is not sufficient.*
 - *Best to identify and begin testing early.*
- ***Final Data Delivery (Launch-7.5 months)***
 - ❑ ***Provide updates to the preliminary data delivery as necessary.***
 - ❑ ***Space Environments may request ASTM E-1559 testing for any unusual materials / analysis drivers.***
- ***Data can be delivered by submission to Space Environments and/or the Payload Integration Manager (PIM) / Research Integration Manager (RIM).***

Integration and Verification Workflow

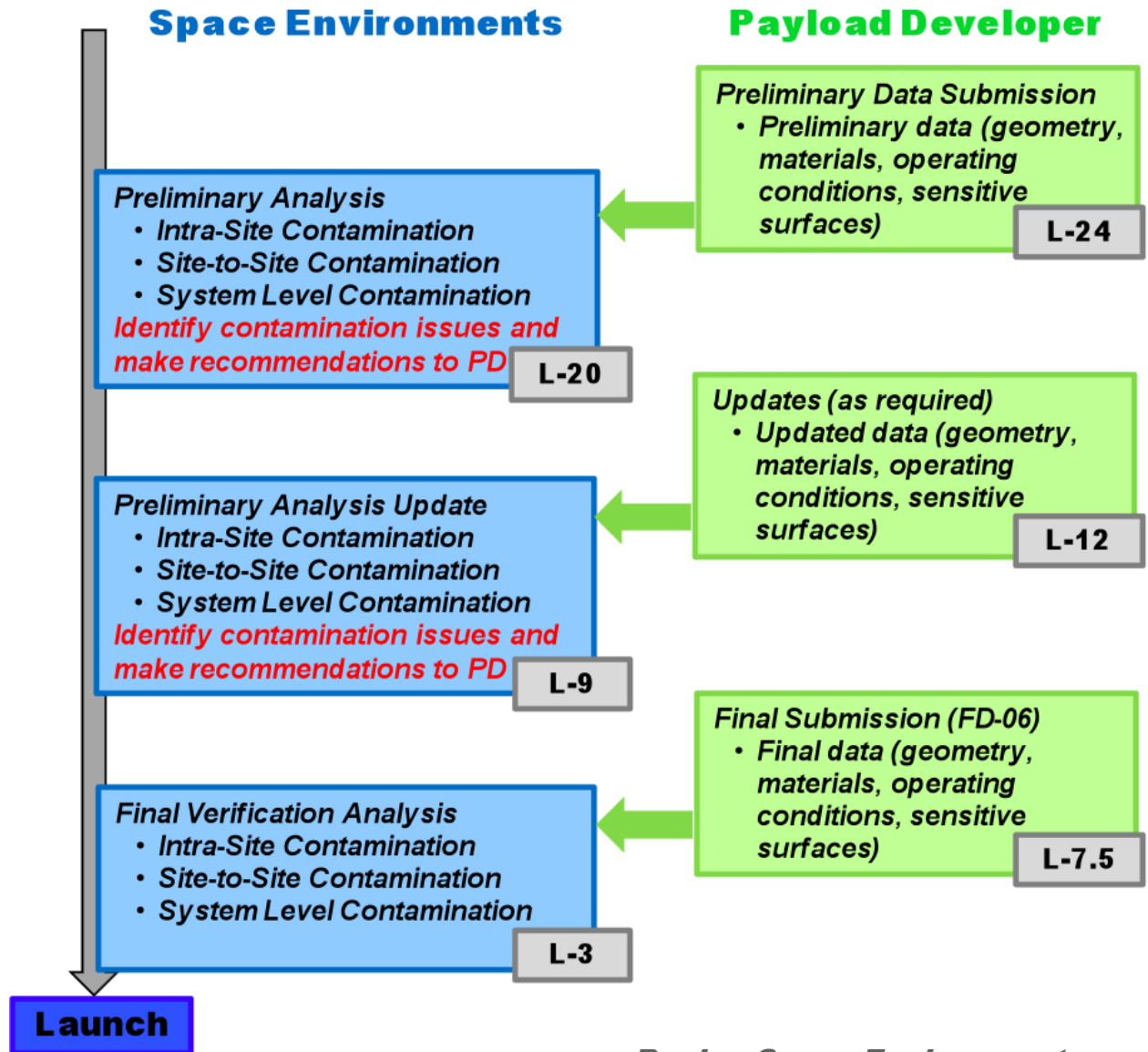



Cargo Vehicle Integration Support for External Contamination



- ***Space Environments conducts materials outgassing analyses for visiting vehicle cargo volumes to provide payloads with deposition data while in transit.***
- ***Currently, analysis data is only available for Cargo Resupply Services-1 (CRS1) / Dragon Trunk.***
 - ***Space Environments has a baseline analysis that gives an estimate from Dragon Trunk materials only.***
 - ***Space Environments can provide a flight-specific materials outgassing analysis (including payload-to-payload contributions) upon request.***
 - ***Note: The Dragon Trunk particulate background has not been characterized, but releases have been observed.***
- ***Materials outgassing analyses for CRS2 / Dragon and Dream Chaser cargo volumes will be performed as material data becomes available.***
 - ***CRS2 vehicles will have a 100 Å limit on sensitive surfaces from the vehicle.****

CRS1 trunk analyses are done as a special service and are not tied to requirements and verification

* SSP 50833 3.2.8.1.5



ELC Payload Contamination Mapping



- ***Contamination forecast maps are generated for U.S. attached payload sites to support payload feasibility, topology and placement studies.***
- ***Now Available: 2018, 2019, 2020 maps.***
- ***Presenting herein, as examples, the 2018 results and summary.***
 - ***Note: As with previous maps, the forecast includes various values above 130 Å/yr.***
 - ***Payloads operating at low temperatures (esp. below -10°C) can experience contamination levels in excess of system level requirements.***
 - ***For a contamination-sensitive payload, Space Environments team works with the payload project to get refined results based on the specific payload geometry and expected operating temperatures.***
 - ***Throughout payload integration, Space Environments team accounts for updates to the ISS configuration and vehicle traffic schedule.***
- ***Detailed analysis data (assumptions and results) for 2018– 2020 available and may be requested via PIM.***



Payload Sites on Analysis Model

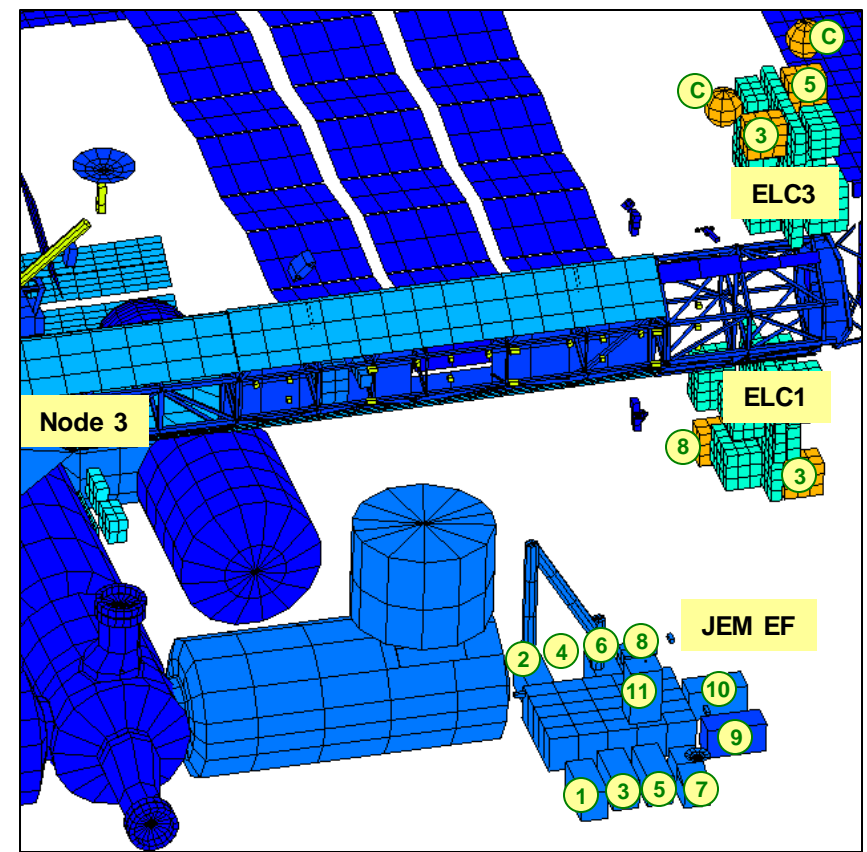
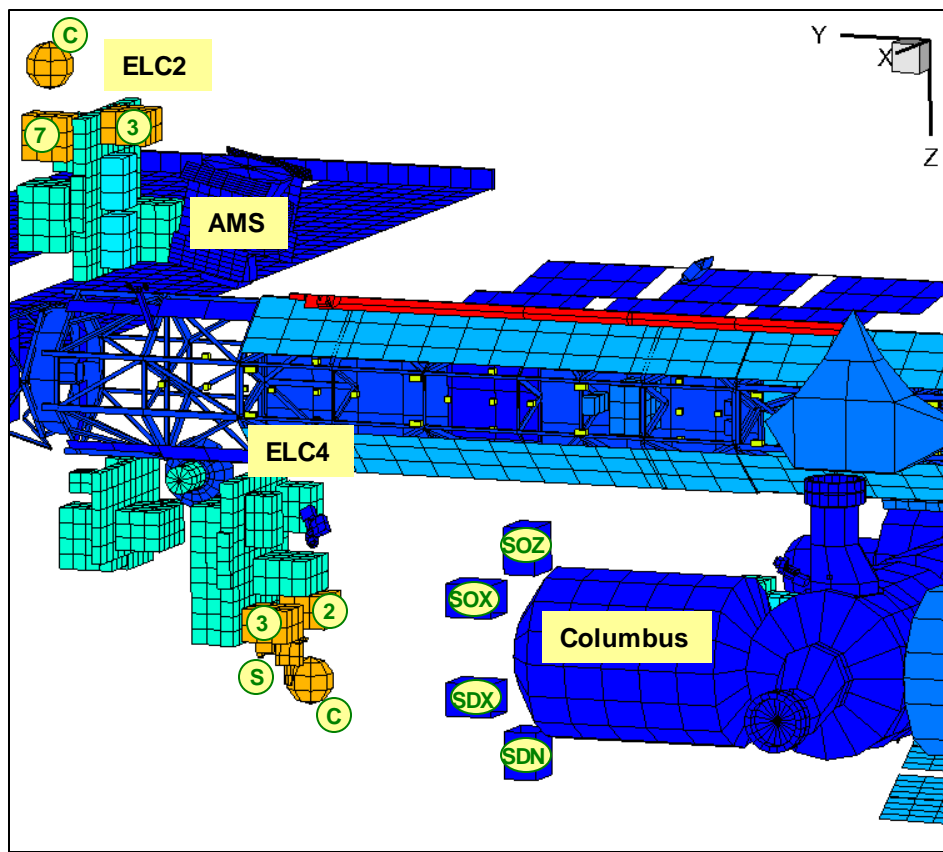

- S = custom model to cover SAGE III payload (contamination-sensitive payload that will exceed generic site volume)
- C = placeholder to address features of candidate rotatable contamination-sensitive payload(s) exceeding generic site volume

ISS Contamination Sources (Nadir View)

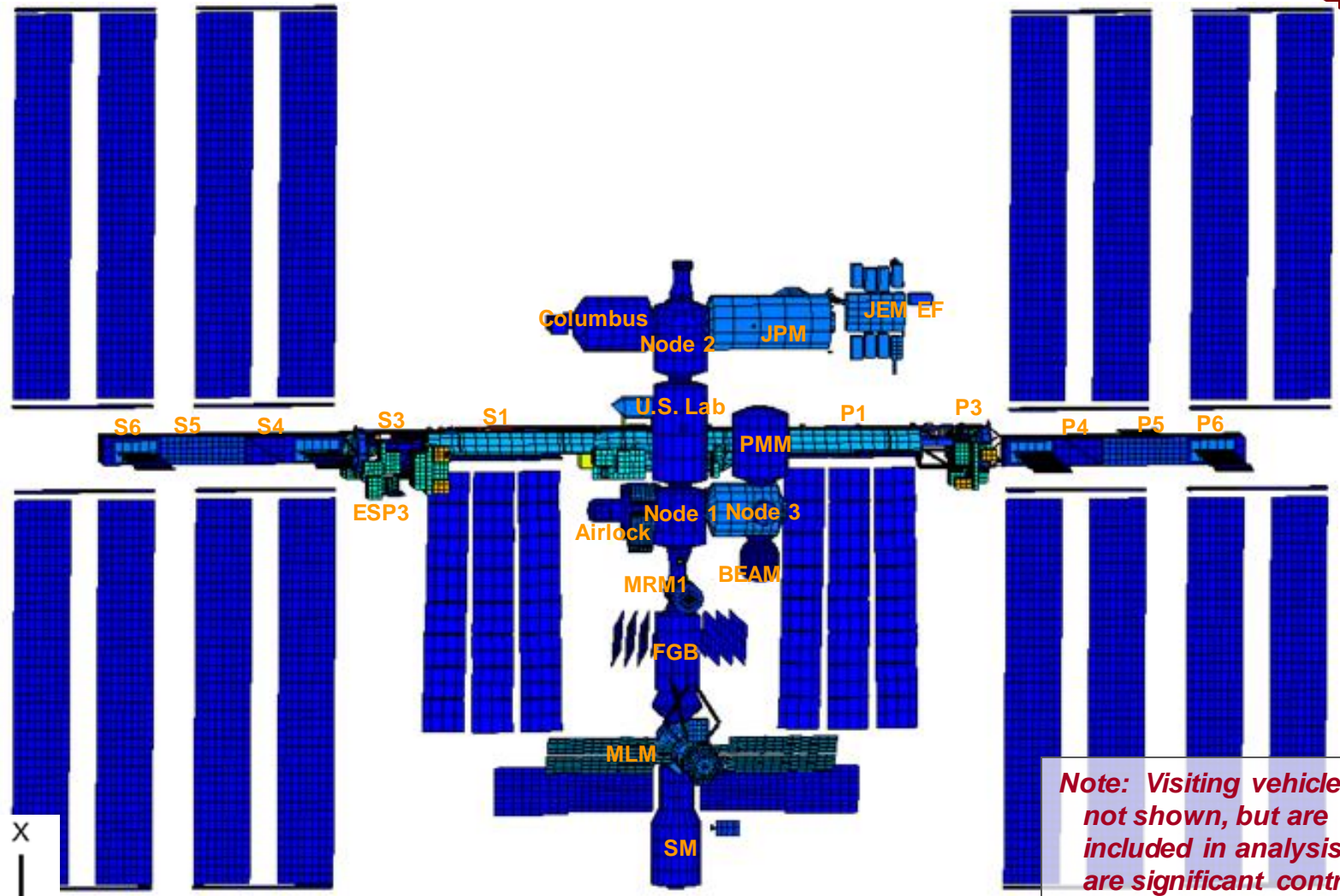

Note: Visiting vehicles are not shown, but are included in analysis and are significant contributors to predicted contamination.



Contour Plots for Starboard Payload Sites: ELC2, ELC4, & AMS

Payload temperatures:

-10°C (typical to conservative)

-40°C (generally conservative)

ELC2 & ELC4 Payload Sites' 2018 Quiescent Contamination Levels at -10°C



Angstroms/year



+X View

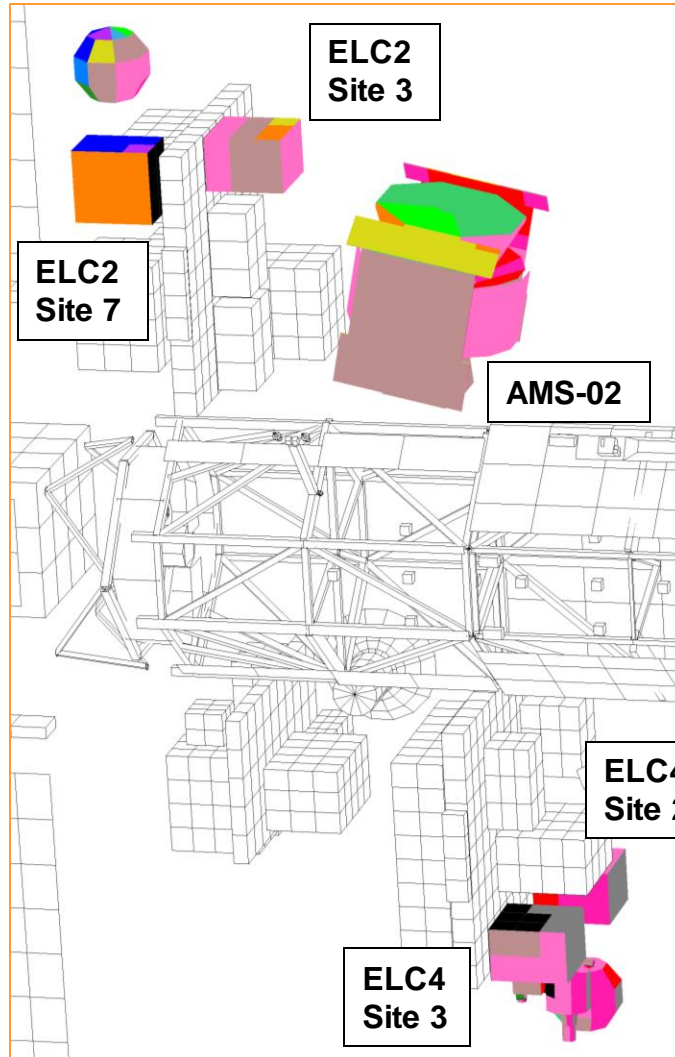

-X View

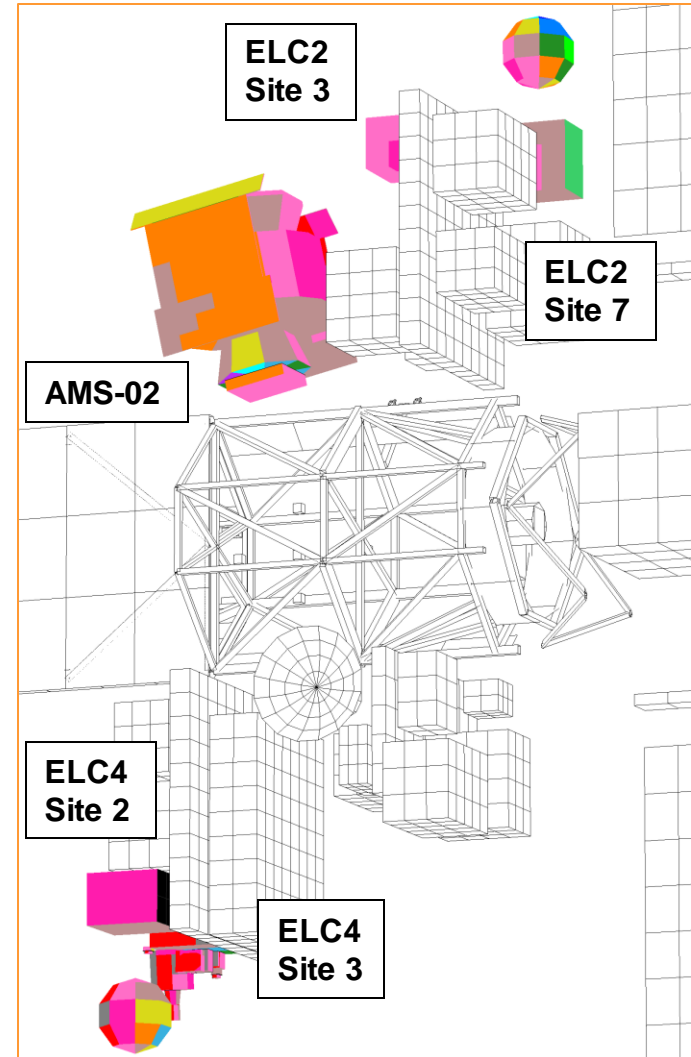

ELC2 & ELC4 Payload Sites' 2018 Quiescent Contamination Levels at -40°C



Angstroms/year



+X View

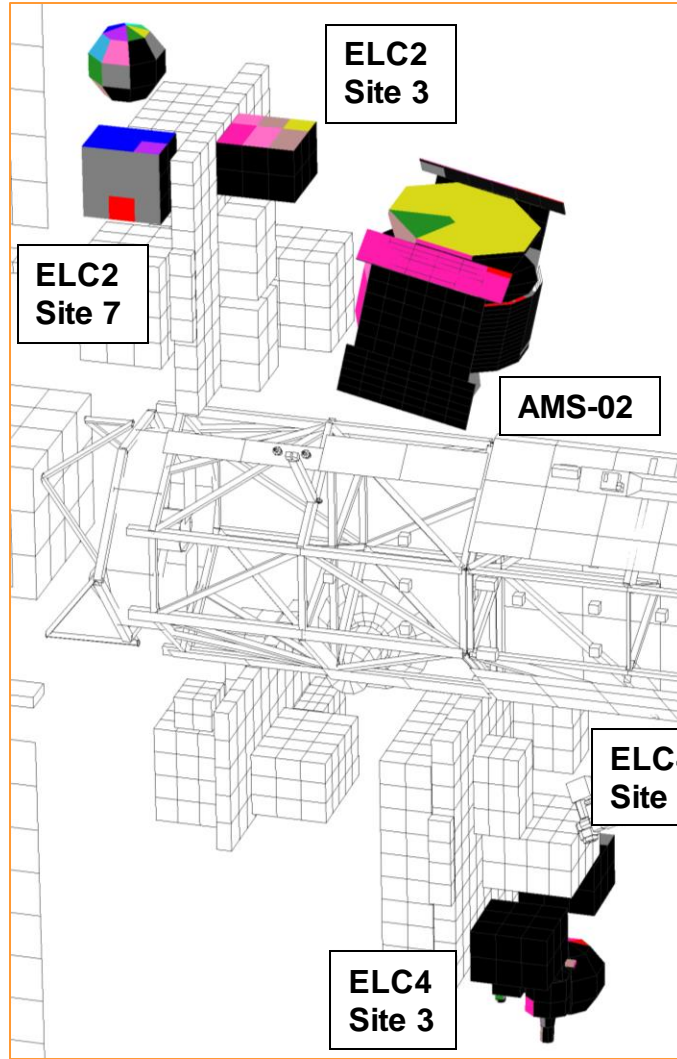

-X View

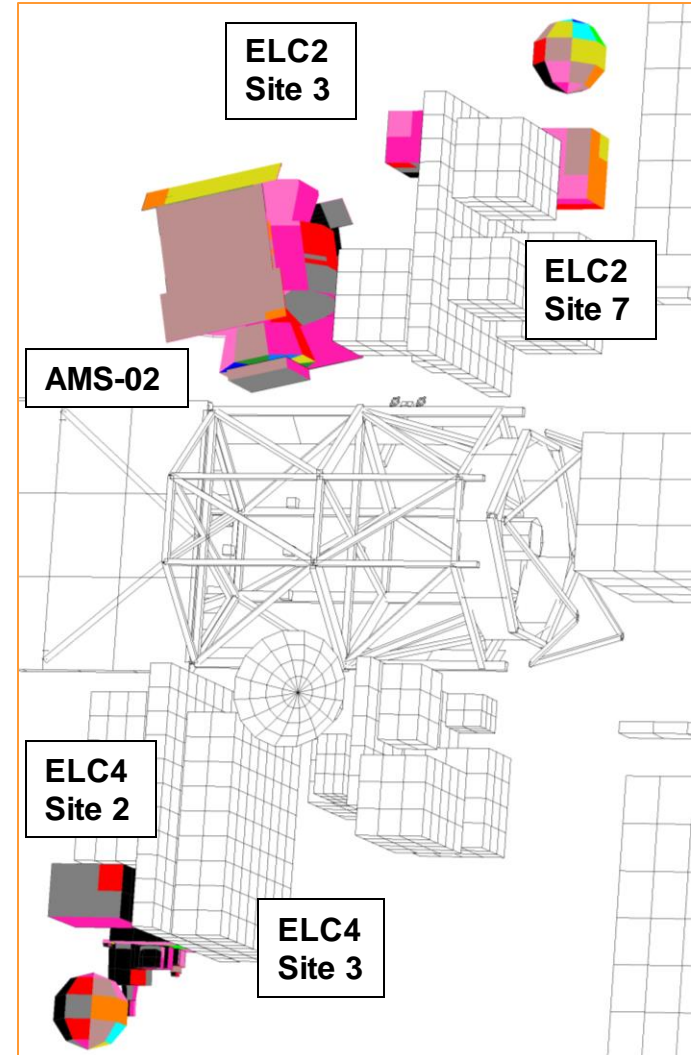



Contour Plots for Port Payload Sites: ELC1 & ELC3

Payload temperatures:

-10°C (typical to conservative)

-40°C (generally conservative)

ELC1 & ELC3 Payload Sites' 2018 Quiescent Contamination Levels at -10°C



Angstroms/year



+X View

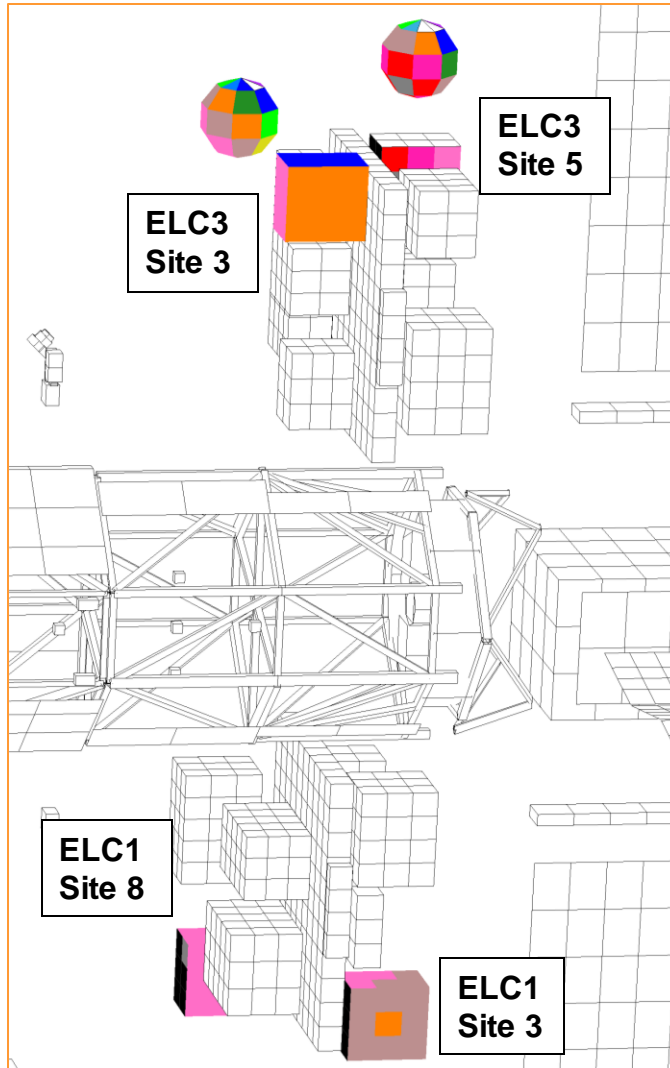

-X View

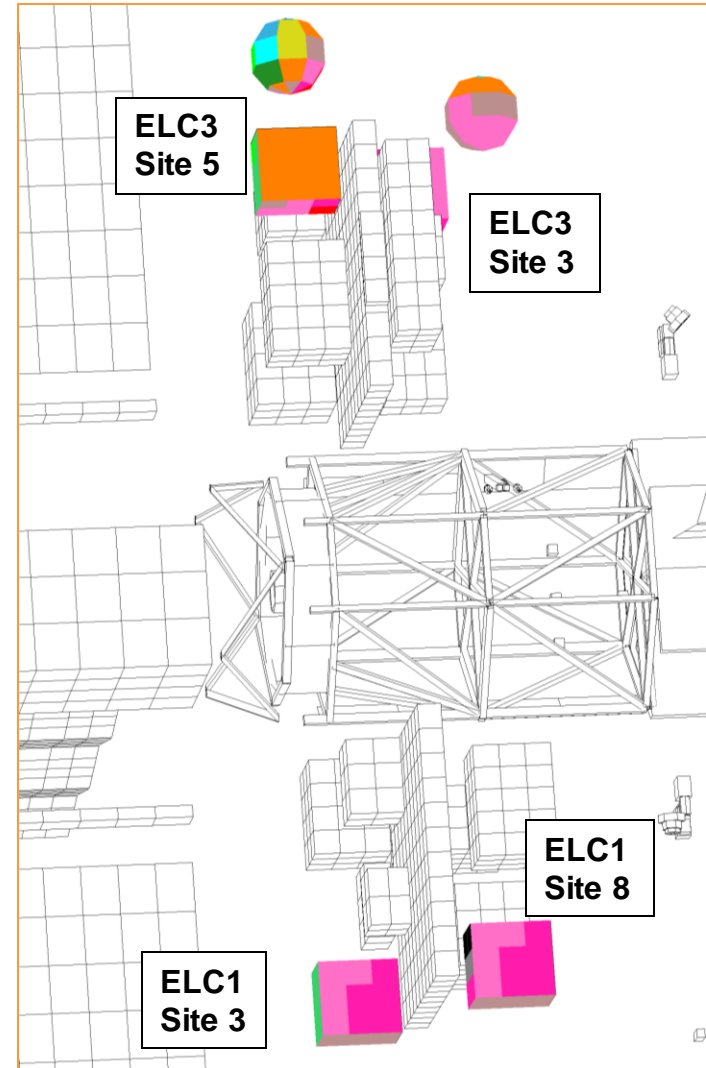

ELC1 & ELC3 Payload Sites' 2018 Quiescent Contamination Levels at -40°C



Angstroms/year



+X View

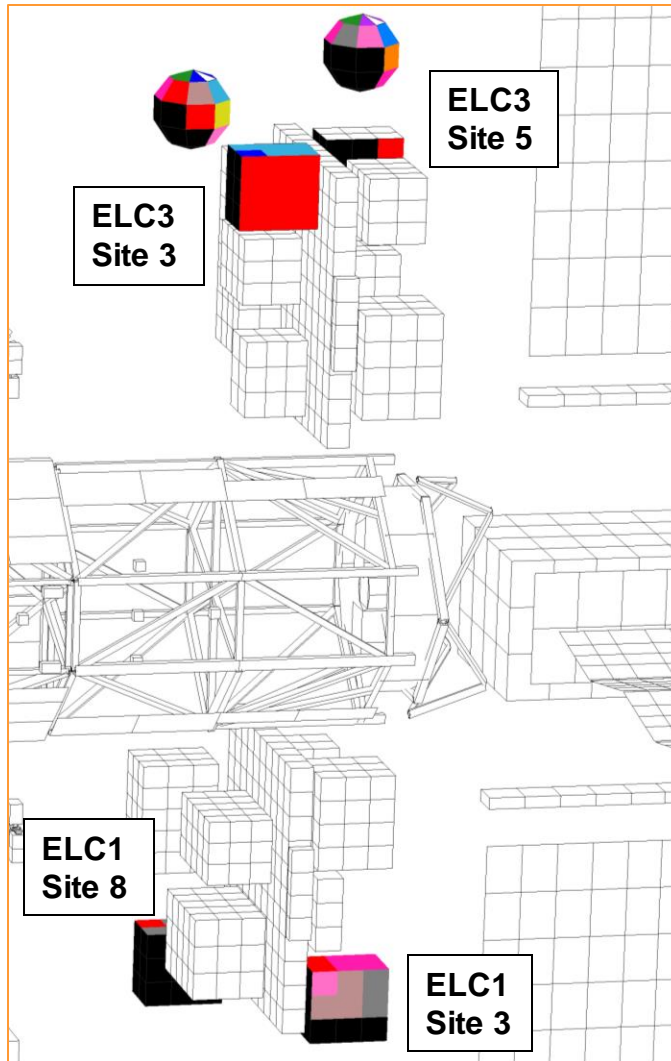

-X View

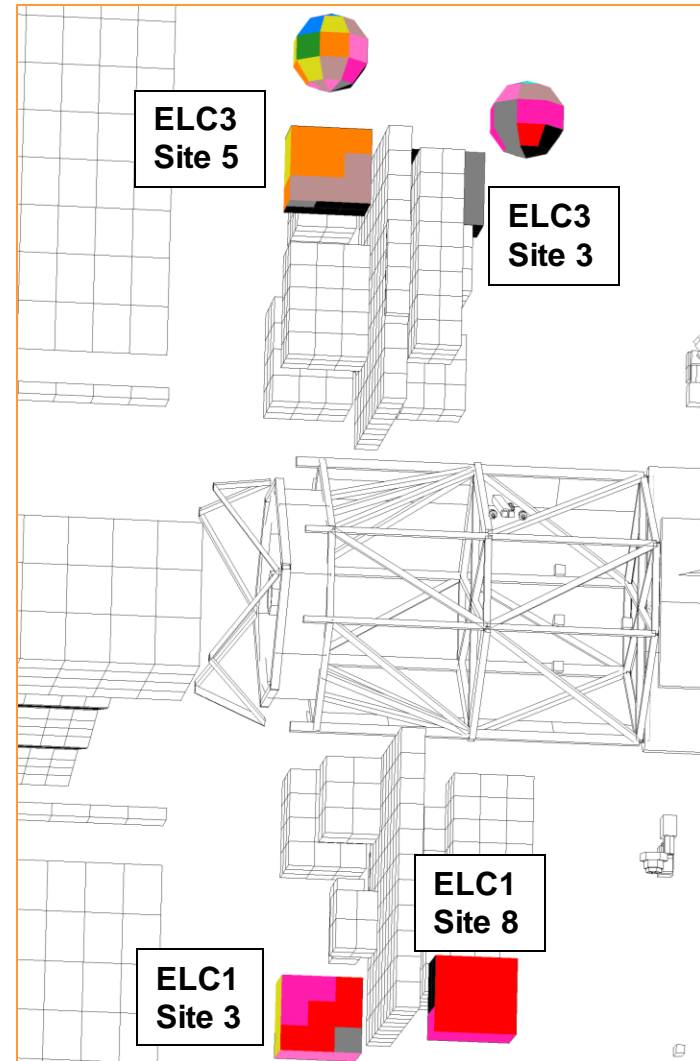



2018 ELC Payload Contamination Mapping Summary

2018 Quiescent Contamination Forecast Map Summary



- **Blue** – Payload envelope surface expected to receive less than 130 Å/year.
- **Red** – Payload envelope surface expected to receive greater than 130 Å/year.
- **Gray** – Payload envelope surface facing ELC [mounting surface].

Payload Site	Contaminant Deposition on Payload Envelope Surfaces in Å/year																	
	+X _{ISS}			-X _{ISS}			+Y _{ISS}			-Y _{ISS}			+Z _{ISS}			-Z _{ISS}		
	25°C	-10°C	-40°C	25°C	-10°C	-40°C	25°C	-10°C	-40°C	25°C	-10°C	-40°C	25°C	-10°C	-40°C	25°C	-10°C	-40°C
ELC1 - Site 3	8.1	21.2	87.1	32.5	49.9	76.6				1.9	2.8	6.4	14.9	20.4	43.2	16.3	32.0	70.3
ELC1 - Site 8	22.8	56.0	246.4	33.6	50.6	85.5	61.2	130.9	511.7				18.6	25.6	53.5	29.3	48.8	117.0
ELC2 - Site 3	6.8	26.8	146.0	28.6	51.2	62.4				14.6	40.0	214.5	19.2	49.6	138.8	2.8	22.5	33.6
ELC2 - Site 7	1.6	11.6	111.0	18.5	36.0	44.6	1.1	2.8	10.8				16.3	34.3	77.7	0.1	0.2	0.2
ELC3 - Site 3	1.8	12.1	81.3	33.3	60.3	149.4	13.3	33.2	177.3				37.4	73.1	214.1	0.0	0.3	0.7
ELC3 - Site 5	37.2	70.9	152.9	9.7	11.3	15.2				1.0	2.6	9.8	25.7	49.0	153.8	0.0	0.1	0.1
ELC4 - Site 2	28.1	67.8	352.8	39.5	60.8	103.0				58.0	116.1	439.7	16.0	26.7	70.0	25.6	43.6	174.2
ELC4 - Site 3	4.1	30.5	207.3	57.0	90.7	223.8				48.9	110.4	488.2	6.6	11.6	35.2	26.1	135.1	286.4

Note: Contamination levels shown are for generic payload envelopes, not actual payload geometries. These are meant to provide initial guidance. Space Environments will work with Payload Developers to obtain more detailed predictions as their designs mature.

Separately, plume-induced (nonquiescent) contribution expected to be no more than 10 Å/yr for any ELC payload surface.



Concluding Remarks



- **Multiple science payloads introduce complex induced contamination environment interactions that must be taken into account for successful integration of the payload complement in operation on ISS.**
- **External payloads are contamination sources and receivers.**
 - ❑ **Payload developers supply the required data certification deliverables characterizing the payload as a contamination source.**
 - ❑ **Payloads must be designed to perform within the ISS induced environment (i.e., 130 Å/year ISS “Design To”/requirement level), which includes contributions from visiting vehicles and its payload complement.**
- **ELC payload sites can receive significant contamination levels from adjacent Orbital Replacement Units (ORUs), and from payloads in close proximity.**
 - ❑ **ELC topology (payload and ORU placement, and proximity to other payloads) is an important consideration in ELC payload integration activities.**
- **2018 – 2020 contamination forecast maps for U.S. attached payload sites are available upon request via PIM.**



BACKUP



Requirements



- **System level requirements are contained in the System Specification for the International Space Station (SSP 41000).**
 - **Call on specific sections of the Space Station Contamination Control Requirements, SSP 30426 (Sections 3.4, 3.5 and 3.6).**
 - **Specify an induced contaminant deposition limit equivalent to 130 Å/year on contamination sensitive surfaces from all sources of contamination on the vehicle combined.**
- **ELC Payloads Interface Control Document (ICD) or Interface Requirements Baseline (IRB) specifies the payload interfaces to ISS and identifies the method of verification, the required verification data inputs and delivery dates.**
- **Payloads designed for deployment on the U.S Segment attached payload sites must comply with contamination requirements detailed in SSP 57003, SSP 57004, and SSP 57011.**



Attached Payloads External Contamination Requirements



- **SSP 57003, “External Payload Interface Requirements Document” Revision L (applicable to the ELC complement):**
 - **Section 3.5.3.1 limits the molecular column density due to venting, leakage and outgassing of a payload site from exceeding along any unobstructed line of sight a value of $1E+14$ molecules/cm² for any individual species, when viewed from any other attached payload location.**
 - **Section 3.5.3.2.A limits a payload site’s contribution to surface contamination of another (truss-based) payload site in the form of molecular deposition via materials outgassing and venting to $1E-14$ g/cm²/s, or equivalently a thickness of 30 Å/yr.**
 - *This section also limits an individual ELC-mounted payload’s contribution to surface contamination of an adjacent payload (on the same ELC) in the form of molecular deposition via materials outgassing and venting to $5E-15$ g/cm²/s, or equivalently a thickness of 15 Å/yr.*
 - **Section 3.5.3.2.B limits a payload site’s contribution to surface contamination of sensitive ISS surfaces in the form of molecular deposition via materials outgassing and venting to $1E-15$ g/cm²/s, or equivalently a thickness of 3 Å/yr.**
 - *This section also limits an individual ELC-mounted payload’s contribution to surface contamination of sensitive ISS surfaces in the form of molecular deposition via materials outgassing and venting to $5E-16$ g/cm²/s, or equivalently a thickness of 1.5 Å/yr.*
 - **Section 3.5.3.3 limits a payload site’s active venting release of particulates to only particulates less than 100 microns in size.**



Attached Payloads External Contamination Requirements (concluded)



- ***SSP 57004, “Attached Payload Hardware Interface Control Document Template”, includes deadlines and actions a payload developer must support for satisfactory closure of verification requirements.***
- ***Analyses are performed to assess compliance with the requirements documented in SSP 57011, Payload Verification Program Plan, and to ensure that the complement of payloads meets ISS interface requirements.***
- ***The payloads are assessed at the element level as well as the ISS system level.***



Columbus and JEM-EF Requirements



- ***Requirements governing integration and verification of payloads on the European Columbus Module are specified in the Columbus External Payloads Interface Requirements Document (COL-RIBRE-SPE-0165).***
 - ***Similar to U.S. Segment requirements in principle, but differ on payload-to-payload induced contamination sub-allocations since the Columbus exposed facility has a different payload topology than the U.S. ELCs.***
- ***Payloads flying on the Japanese Experimental Module Exposed Facility (JEM-EF) are governed by the Exposed Facility/Payload Standard Interface Control Document (JPAH Vol. 3, NASDA-ESPC-2563).***
 - ***JEM-EF requirements specify compatibility with the ISS system level requirements but do not make specific sub-allocations for payload-to-payload induced contamination level within the JEM-EF.***
 - ***JAXA conducts induced contamination analyses to ensure successful integration of payloads within the JEM-EF.***



Materials Outgassing



- ***Required data for all non-metallic vacuum exposed materials:***
 - ❑ ***Material identification***
 - ❑ ***Location of application on payload***
 - ❑ ***Vacuum exposed surface area***
 - ❑ ***Nominal operating temperature range***
 - ❑ ***Outgassing rate data from ASTM E1559 testing***
- ***The preferred format for the definition of operating temperature data for payload materials is one that specifies the percentage of time spent under 30°C, between 30° C and 60°C, and between 60°C and the maximum operating temperature.***
 - ❑ ***This type of definition removes excessive conservatism from the analysis when compared to an analysis using only maximum operating temperature data.***



Outgassing Rate Data



- ***Outgassing rate data from ASTM E1559 testing is required to support induced contamination analysis.***
- ***Testing for the ISS Program is based on Method B of the ASTM E1559 standard.***
 - ***Minimum test duration of 144 hours***
 - ***Four Thermally-controlled Quartz Crystal Microbalances (TQCMs) are used for condensable outgassing rate measurements.***
 - *TQCMs are held at 80K, -40°C, -10°C and +25°C.*
 - *Selection of these temperatures was based on the operating temperatures of ISS contamination sensitive surfaces which include active and passive thermal control system radiators, laser retro-reflectors, windows, sensors and science payloads.*



ASTM E 1559 Standard

- **Standard U.S. method for characterizing materials outgassing rates.**
- **Sample is placed in a temperature controlled effusion cell and outgassing flux leaving the cell orifice impinges on four Quartz Crystal Microbalances (Method B) for 144 hours.**

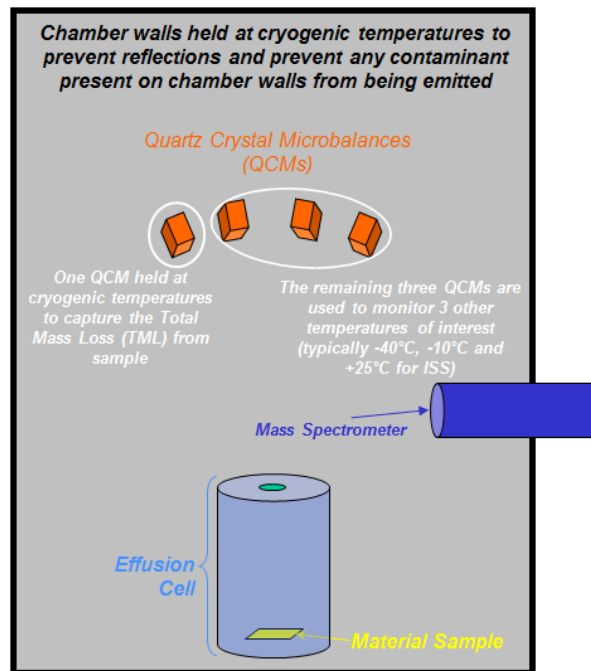

Adapted from [2] Garrett, J.W., Glassford, A.P.M., and Steakley, J.M., "ASTM E 1559 Method for Measuring Material Outgassing/Deposition Kinetics," *Journal of the Institute of Environmental Sciences and Technology*, pp. 19-28, January/February 1995.



Contamination Mapping Objective



- ***Produce a forecast map with yearly contamination estimates for all Express Logistics Carrier (ELC) payload sites for designated year.***
 - ***Forecast the ISS system level contamination environment at ELC payload sites (130 Å/year requirement), which includes contributions from all sources of contamination (ISS and Visiting Vehicles).***
- ***Contamination forecast maps support payload feasibility, topology and placement studies.***
- ***Forecast maps are also used to identify potential integration issues of the ELC payload complement.***

Note: Previous Payload Contamination Forecast Map was delivered in August 2014.



Expected ISS Payloads in 2018

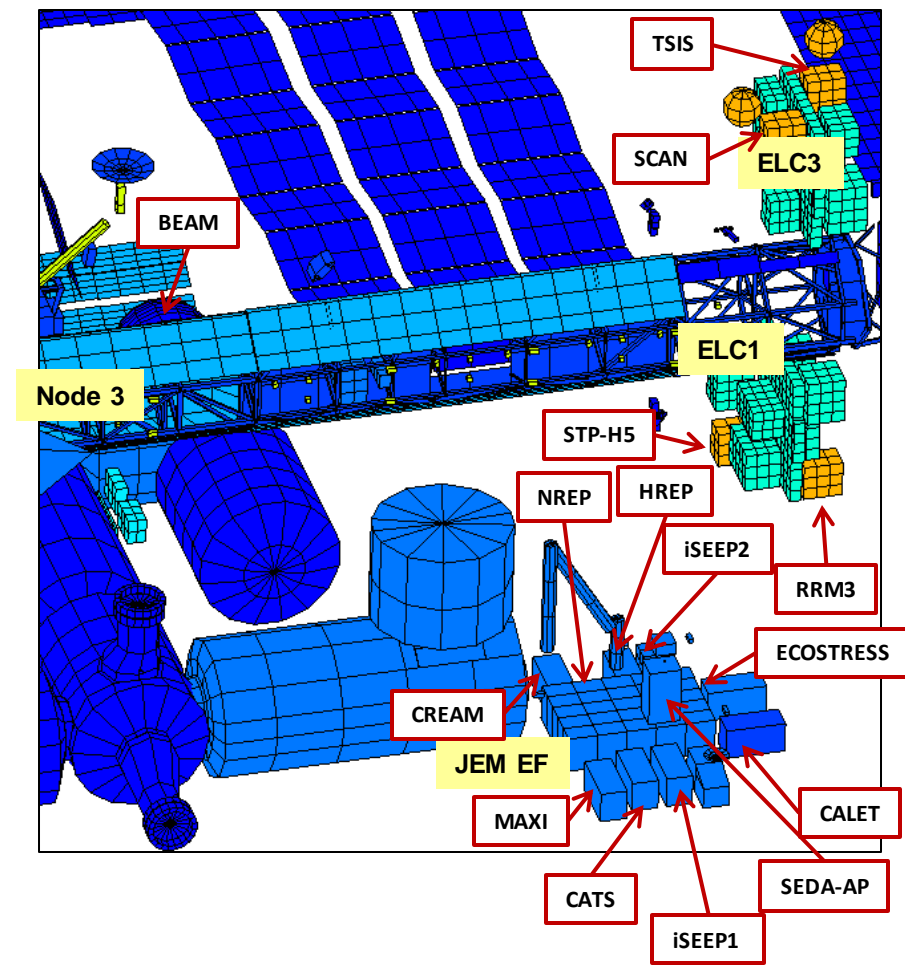
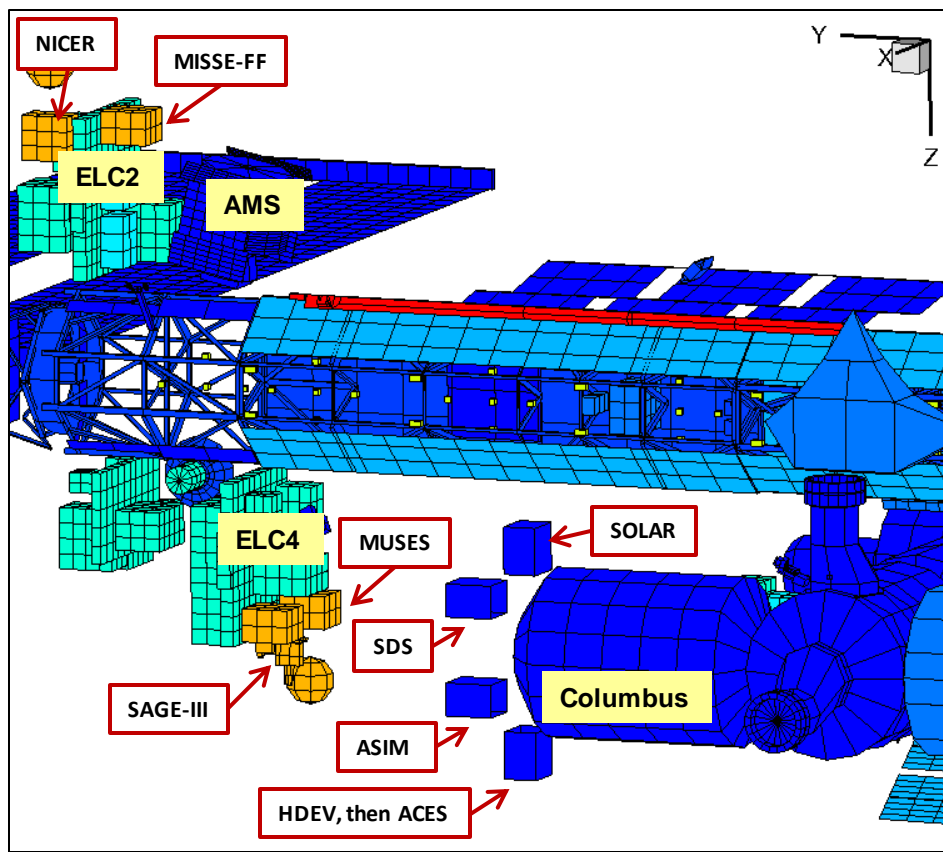



Expected ISS Payloads in 2019

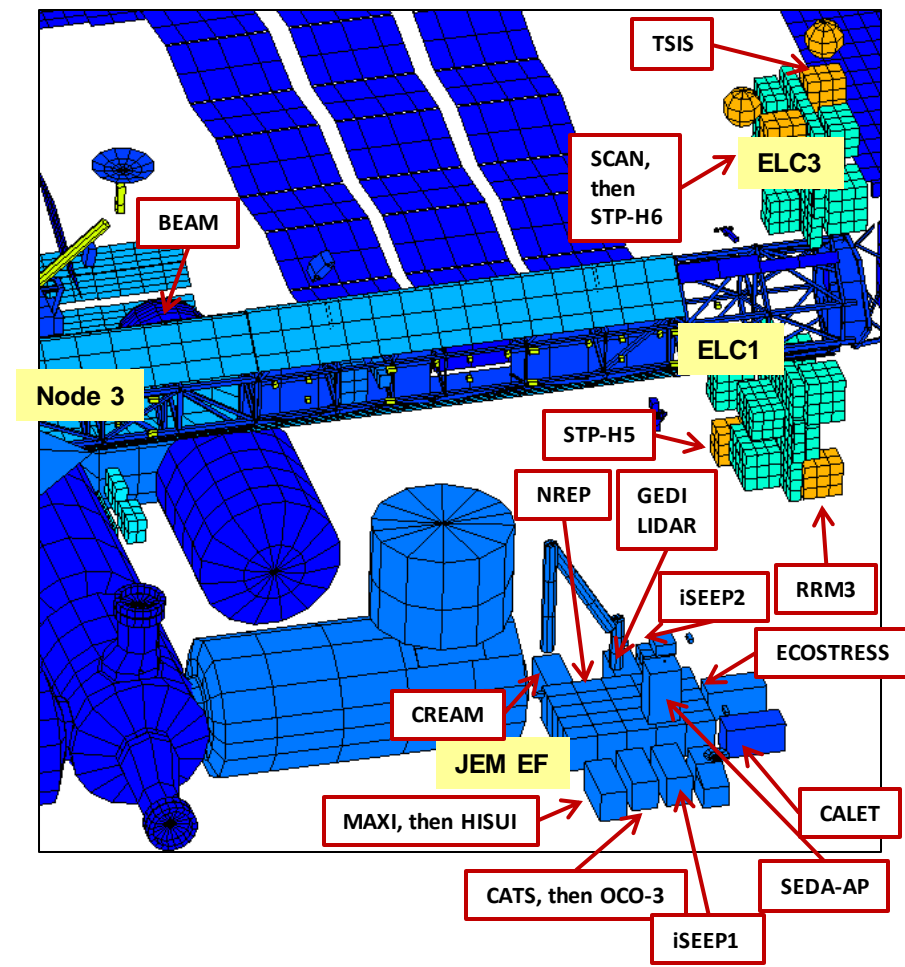
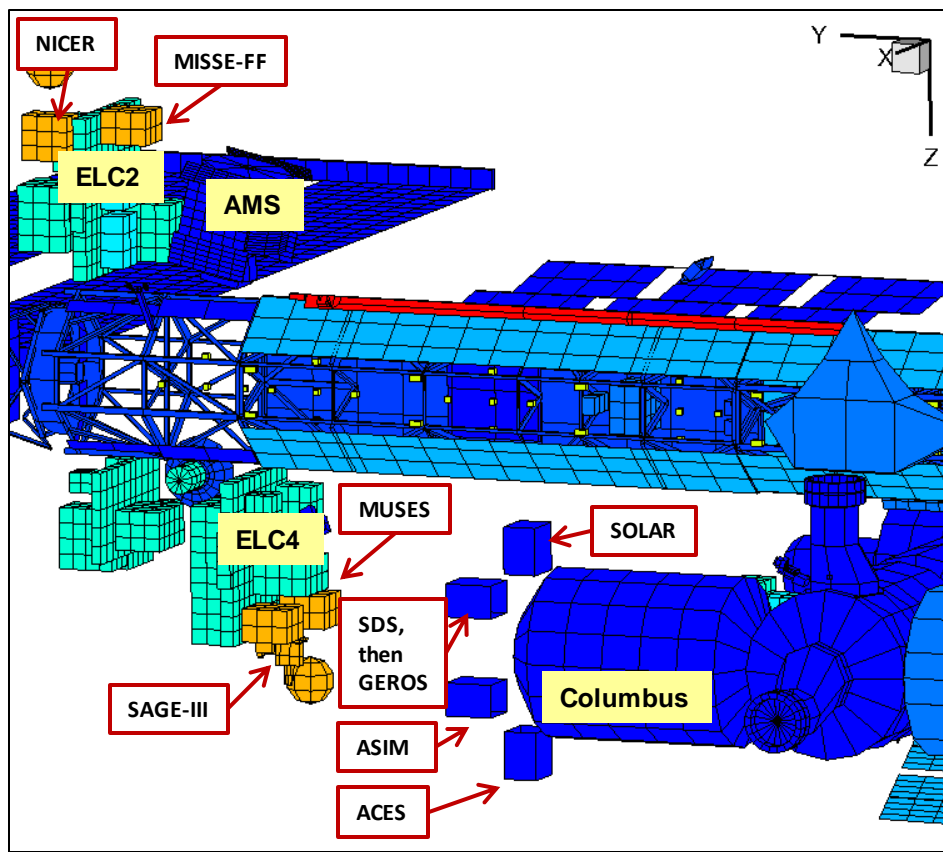



Expected ISS Payloads in 2020

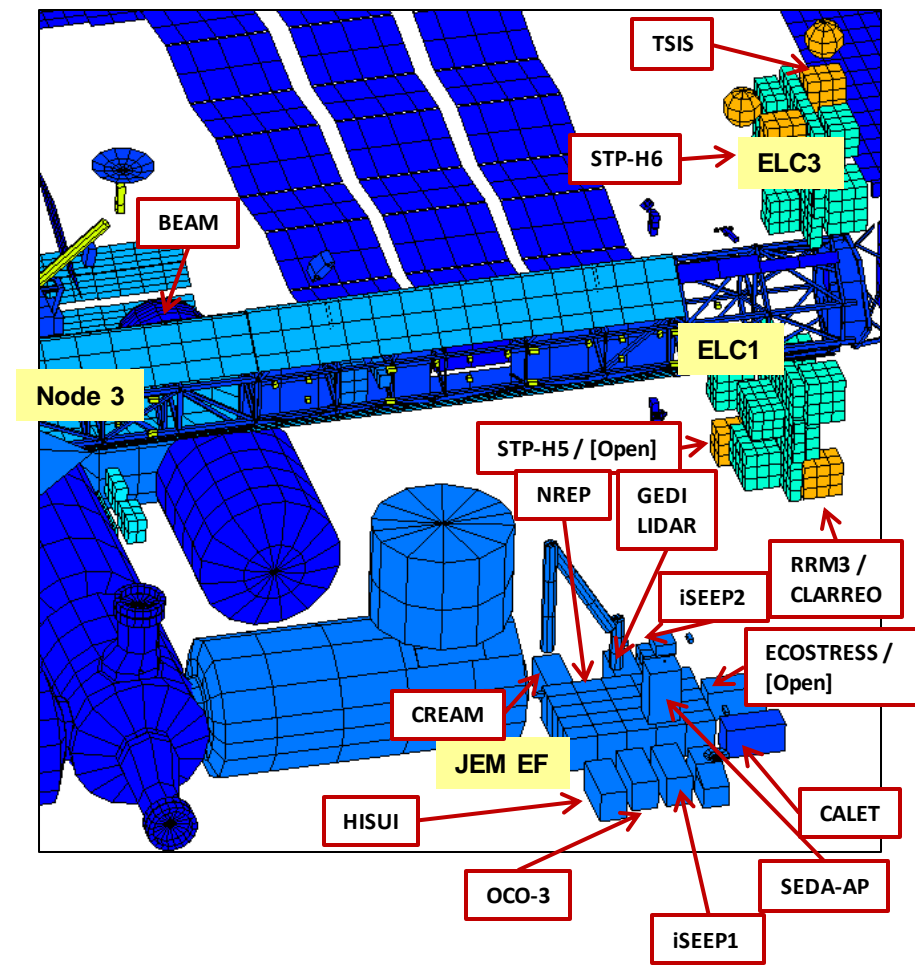
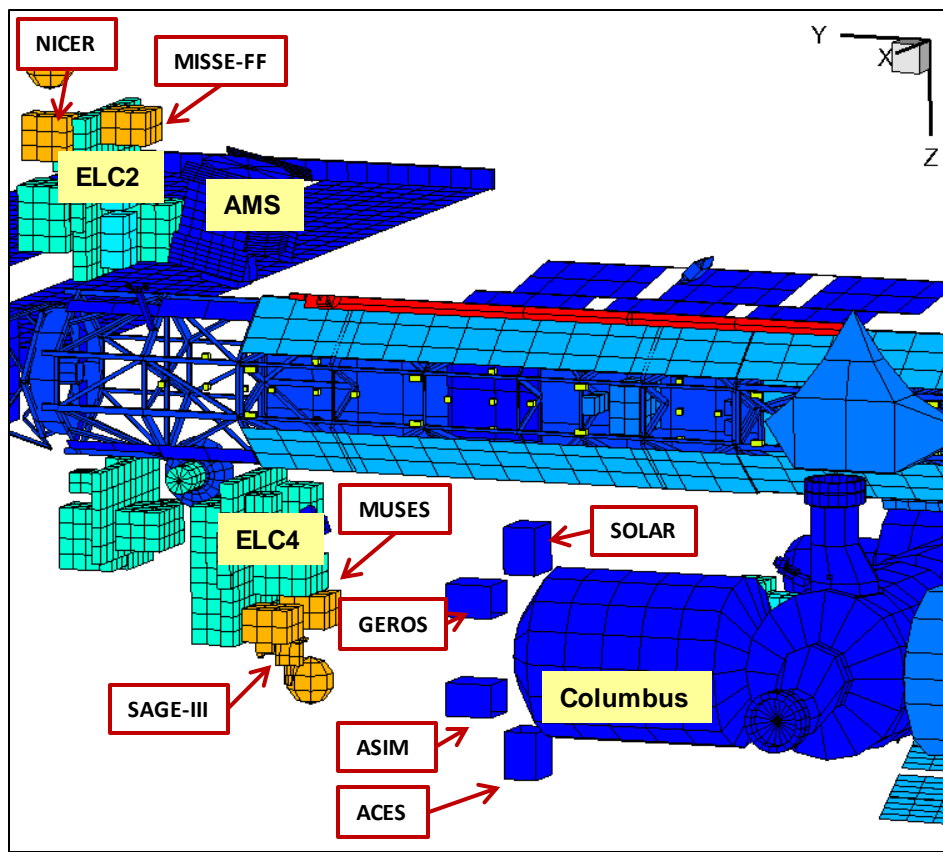



Modeling Considerations



- ***Payload sensitive surfaces are modeled with envelopes at +25°C, -10°C, and -40°C cases.***
 - ***Actual contamination levels for payload specific sensitive surfaces are assessed during payload integration phase.***
- ***These contamination estimates do not include contributions from cargo vehicles prior to deployment to ISS (i.e., while inside the cargo vehicle during free flight and mated phases).***
 - ***Cargo vehicle induced contamination contribution prior to deployment is not included in the 130 Å/year ISS system level requirement.***



Payload Mapping Sites



- ***Two payload sites exist on each of four ELCs.***
 - ***Known payloads extending outside the envelopes have been incorporated.***
- ***A non-ELC attachment point along truss hosts Alpha Magnetic Spectrometer (AMS-02).***
- ***Columbus and Japanese Exposure Module Exposed Facility (JEM-EF) payloads are only included as contamination sources to the ELC payload sites.***
 - ***Contamination Forecast Mapping activity task is limited to ELC payload sites; Columbus and JEM-EF payloads are outside of the scope of this activity.***



ISS Contamination Sources Materials Outgassing



- **Visiting vehicle traffic for 2018-2020 has been modeled after Flight Program Integration Panel schedules.**
- **Contributions from the following are not included as these hardware items move frequently and have low outgassing rates:**
 - ❑ **Space Station Remote Manipulator System, Mobile Transporter, Mobile Base System, and Special Purpose Dexterous Manipulator**
- **Contributions from the following hardware items in the design phase will be included in future map deliveries once designs mature:**
 - ❑ **More specific crewed vehicle components***
 - *Dragon CRS1 outgassing results currently being used for each crewed vehicle (Dragon 2, CST-100 and USCVs)*
 - ❑ **CRS2 cargo vehicle components***
 - *CRS1 vehicle results currently being used*
 - ❑ **New payloads**
 - ❑ **Russian OKA-T vehicle***

*** Contributions expected to be significant**



ISS Contamination Sources Plume Contamination



- ***Thrusters produce contamination (and mechanical erosion) of exposed surfaces which can impact optical properties and performance.***
- ***Truss-based payload sites, being far from all docking port centerlines, are predicted to receive no more than 10 Å/year on any surface (based on existing attitude control and visiting vehicle studies).***
 - ***Contributions from Russian vehicle proximity operations still are under evaluation for multiple docking ports (including MLM/Node).***
 - *Russians have provided updated jet firing history sets.*
 - ***Contributions from proximity operations for commercial crewed vehicles and CRS2 cargo vehicles are unknown. Input data not yet available.***



ISS Contamination Sources Plume Contamination (concluded)



- ***The bipropellant ISS and visiting vehicle thrusters use hypergolic components, either monomethyl hydrazine (MMH) or unsymmetrical dimethyl hydrazine (UDMH) as fuel and nitrogen tetroxide (NTO) as oxidizer.***
- ***Exception: Cygnus vehicles use monopropellant MMH thrusters.***
- ***Plume-induced deposition occurs via liquid phase / droplets.***
 - ❑ ***Fluence to ELC payload sites, though expected to be low, cannot be precluded.***
- ***Plume-sensitive payloads may seek to mitigate contamination and erosion from plumes through inclusion of baffles / covers in payload design.***



Summary of Mir Observations



Mir External Contamination Observations

- **Comes-Aragatz (CNES)** **350 - 780 Å** **in 13 months**
- **Camera Bracket (NASA)** **12,000 Å** **in 4 months**
- **ICA QCM 1 (ESA)** **13,000 Å** **in 3 months**
- **ICA QCM 2 (ESA)** **14,500 Å** **in 3 months**
- **ICA QCM 3 (ESA)** **4,500 Å** **in 3 months**
- **Trek Blanket (NASA)** **> 20,000 Å** **in 4.2 years**
- **Astra-II (RSC-Energia)** **5,000 Å** **in 13 months**

Predictions & Correlations with Measurements: MISSE



- Returned materials samples from MISSE flight experiment confirmed low levels of induced contamination from U.S. Segment hardware

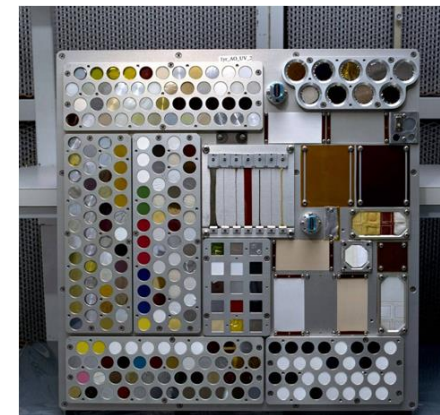
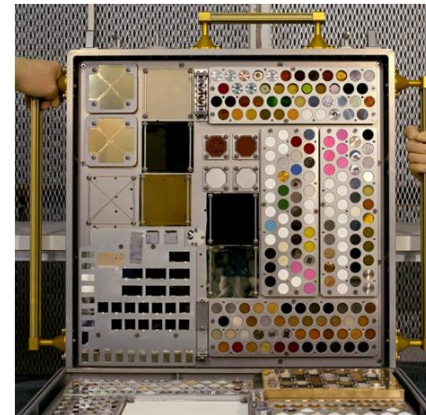
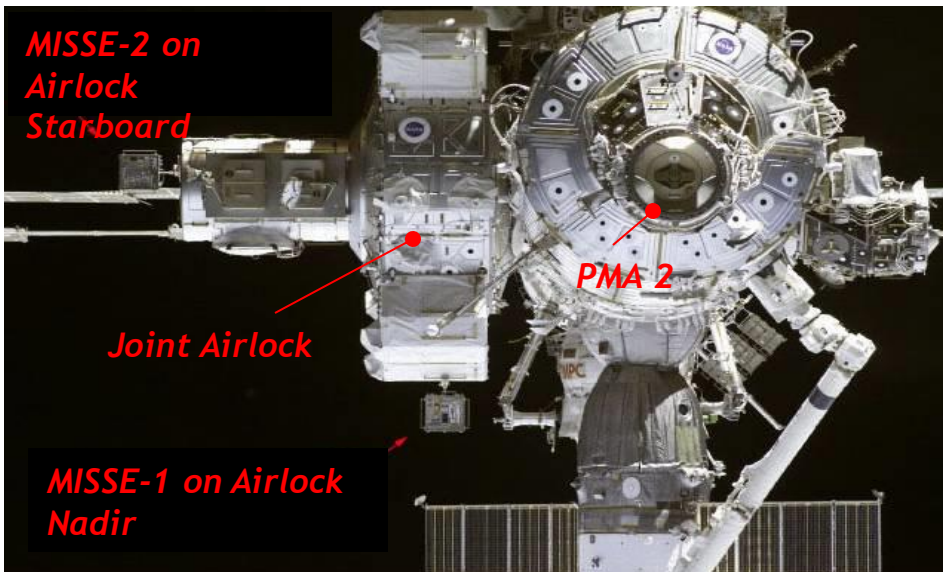

Predictions & Correlations with Measurements: MISSE



- **ISS induced contamination levels on MISSE were measured on ram and wake facing MISSE gold mirrors (WR 200802140)**
 - ❑ **Measured wake facing mirror contamination was less than 500 Å**
 - ❑ **Measured ram facing mirror was less than 50 Å**
- **Excellent agreement between predicted and measured contamination results for the 4.0-year flight**

Experiment	Side	Predicted	Measured
MISSE 2	ram	80 Å	50 Å
	wake	730 Å	500 Å

- *Dominant contamination source for ram surfaces is Orbiter*
- *Dominant sources for wake surfaces are FGB and docked Soyuz vehicles*